

OSID Positioning

Guidelines for Territories without
National or Regional installation
codes for beam detectors

Application Note

February 2017

Doc. 25686_02

Contents

1	General	2
2	Basic principles of smoke behaviour.....	2
	2.1 The smoke plume.....	2
	2.2 Stratification	3
	2.3 External factors that affect smoke movement	3
3	Positioning Emitters and Imagers	4
	3.1 Maximum beam length and covered surface	4
	3.2 Maximum height for installing beam detectors	5
	3.3 Distance from the ceiling	5
	3.4 Spacing between beams	5
	3.4.1 Distance from the walls.....	5
	3.4.2 Flat roofs.....	6
	3.4.3 Apex.....	6
	3.4.4 Atrium	6
4	Positioning for special applications.....	8
	4.1 General	8
	4.2 Free view	8
	4.3 Cross talk	9
	4.3.1 Cross talk using 90° Imager	9
	4.3.2 Cross talk using 10° Imagers.....	9
	4.4 Areas with very bright environments.....	11

1 General

The location and spacing of detector system components should comply with national and regional installation codes.

OSID is recognised by Standards to be equivalent to a traditional beam detector. Some territories have no local codes and refer to manufacturers' guidelines for positioning and installation. This document aims to provide guidance for these territories:

2 Basic principles of smoke behaviour

2.1 The smoke plume

Smoke is a collection of airborne solid and liquid particulates and gases emitted when a material undergoes combustion or pyrolysis, together with the quantity of air that is drawn or otherwise mixed into the mass.

Rising smoke typically forms a 'plume' with a classic 15° cone.

Smoke density and heat reduce with height due to air being drawn into the plume.

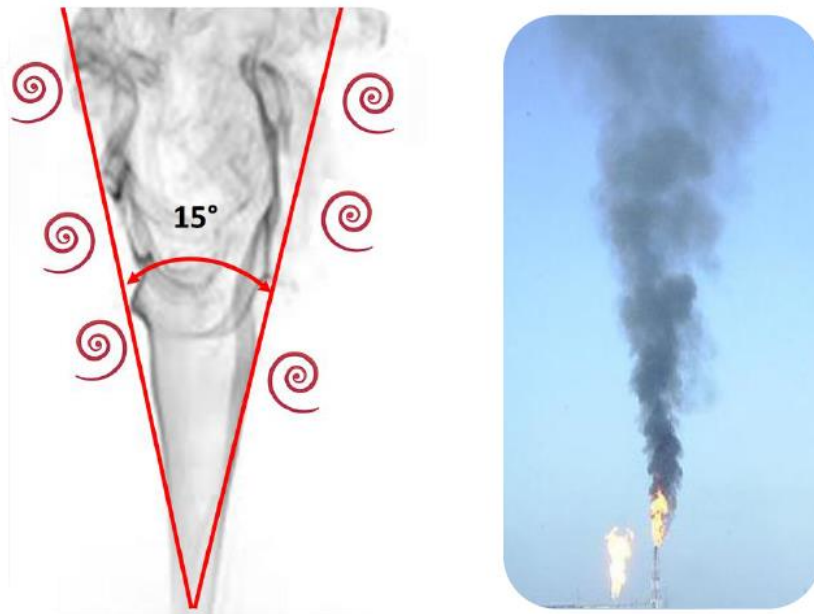

2.2 Stratification

As the plume rises towards the ceiling it draws more air which causes it to cool and slows its upward progression. As the fire develops, the increasing heat output pushes smoke toward the ceiling.

As the smoke plume rises it may cool such that the temperature matches that of the ambient air temperature. In this case the plume will start to spread out against the hotter air layer as if hitting an invisible ceiling.

The creation of this hot air cushion is called 'stratification'.

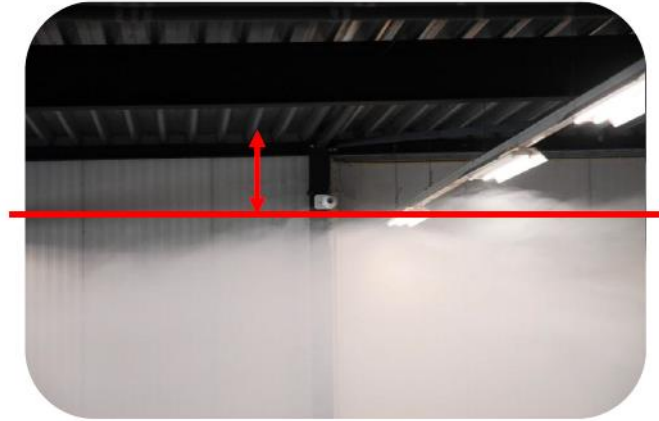

The depth of stratification under the ceiling can vary significantly between summer and winter.

Since it is difficult to predict the resulting stratification depth and it may prove necessary to install multiple layers of detectors at lower heights. Because the plume is narrower nearer the base of a fire than at the stratification or ceiling level, supplementary beam detection will also have to be installed closer together. Refer to section 3.4 for spacing information.

Be advised that during live tests it is very difficult, if not impossible, to see or judge stratification from ground level. Smoke may look very dense from below but it might not have reached the installed beam(s).

2.3 External factors that affect smoke movement

Ventilation may cause air drafts that cause asymmetric smoke movement and affect the behaviour and quantity of smoke in the detector beam path.

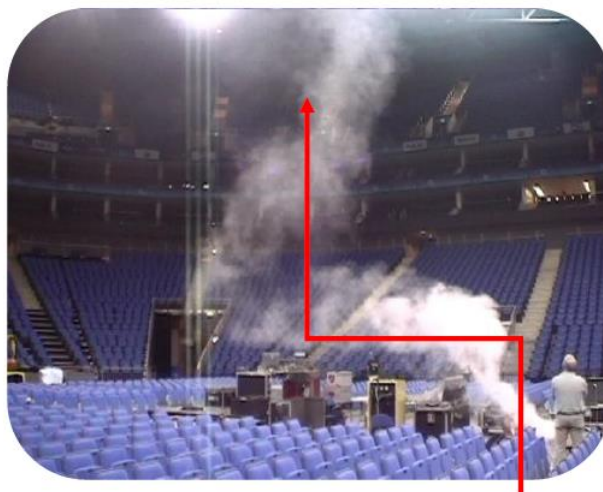

Shelving and racking will channel smoke. The 'chimney' effect assists smoke rise in between the racks.



Note

When protecting areas with a high risk of issues, beam locations and quantity should be confirmed by live testing.

3 Positioning Emitters and Imagers

For areas that require multiple lines of protection, the Emitters should be located and spaced according to the recommendations below to provide full coverage of the protected space.

Multi-Emitter solutions follow the same rules as one-on-one installations.

The maximum allowable distance between Emitters (Y) applies at the locations furthest away from the Imager. The **OSID Selection Assistant tool** will assist in determining the exact number and location of the Emitters.

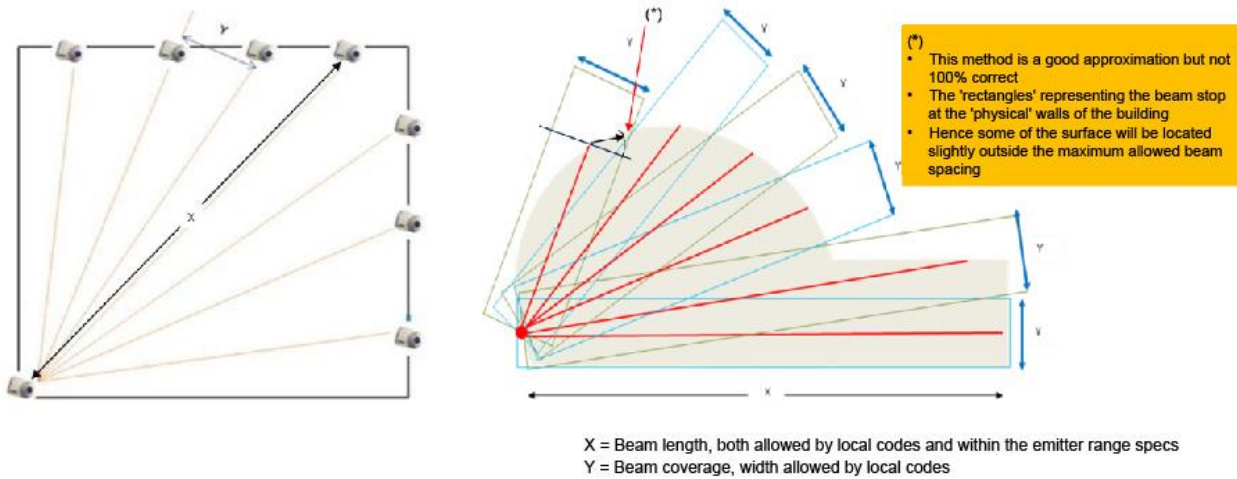

3.1 Maximum beam length and covered surface

Imager Lens Type	Usable Field of View		Detection Range				Max. Numbers of emitters
	Horizontal	Vertical	Standard Power		High Power		
			Min	Max	Min	Max	
10°	7°	4°	30 m (98 ft)	150 m (492 ft)	--	--	1
90°	80°	48°	6 m (20 ft)	34 m (111 ft)	12 m (39 ft)	68 m (223 ft) / 50 m (164 ft)*	7

* Range for OSE-HP-01

The OSI-10 with standard power Emitter (both battery powered and wired) has been tested and is approved to be used up to a distance of 150 m.

For ceiling mounted installations with flat ceilings, OSID can cover an area of 2250 m²¹.

For sloped ceilings, the coverage increases up to 2813 m² for a slope of 25°.

The standard rules for spacing are found in section 3.4

Distances and spacing are listed for normal use in normal areas.

To operate correctly OSID must usually have a clear line of sight between the Emitter and Imager units. While it is designed to be tolerant of severe nuisance events such as obstructions, dust plumes and water spray, it is not intended for use in areas that are routinely subject to extended partial blockages at high levels of obscuration. In the majority of cases, such partial blockages will result in the signalling of a fault (trouble).

¹ In some regions, fire codes prohibit the maximum allowed area of protection for a single detector to smaller values, e.g. 2000 m² or 20,000 sq.ft)

However, in some instances and in order to err on the side of safety, extended and severe partial obstructions caused by dust, fog, semi-transparent objects etc. may be interpreted as smoke and cause an alarm. The effect of nuisance partial blockages may be mitigated by reducing the separation between Emitter and Imager.

In some extreme cases, even reducing beam distances may not provide a solution. For these particular sites, an aspirating smoke detection system (ASD) is the right choice. For any special and/or challenging applications, contact Xtralis Field Application Engineers for support.

3.2 Maximum height for installing beam detectors

Beam detection can generally be installed up to 25 m and even as high as 40 m. Consideration should be given to systems installed above 25 m height. Without intermediate detection smoke will take longer to rise to the beams. Hence fire growth will have increased and an immediate response by the local fire brigade is critical.

The 40 m beam height level was established through testing conducted by the Building Research Establishment (BRE) together with the British Fire Industry Association (FIA). The project confirmed the performance of both ASD and beams in high ceiling applications. The 40 m recommendation assumes that there is no stratification and that smoke rises to the ceiling unimpeded. The use of supplemental detection is recommended unless the risk (i.e. probability x consequence) of stratification is minimal. If stratification exists, detection may be delayed until the heat produced by the fire is sufficient to penetrate the stratification layer. It is recommended that, when beams are used at 40 m height, a minimum sensitivity of 35% obscuration or better is selected. 40 m is allowed for property detection (type P).

3.3 Distance from the ceiling

For roofs up to 12 m height and with a maximum angle of 20° beams are typically installed 60 cm to 90 cm below the ceiling,

For roof angles greater than 20° and higher than 12 m, detectors should be positioned 80 cm to 120 cm below the ceiling.

3.4 Spacing between beams

3.4.1 Distance from the walls

Imagers and Emitters are typically mounted on solid walls and solid structures. It is however permissible to mount the units at a distance of 3.75 m (max) from the wall. Mounting distances to the ceiling must be as section 3.3.

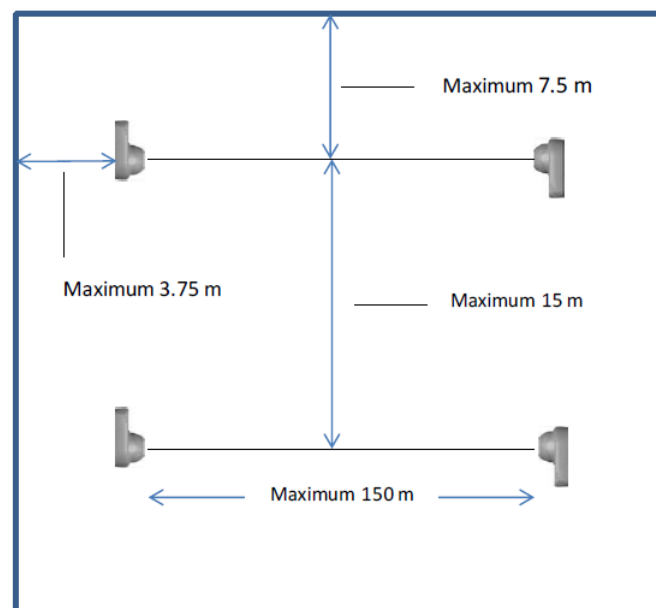

3.4.2 Flat roofs

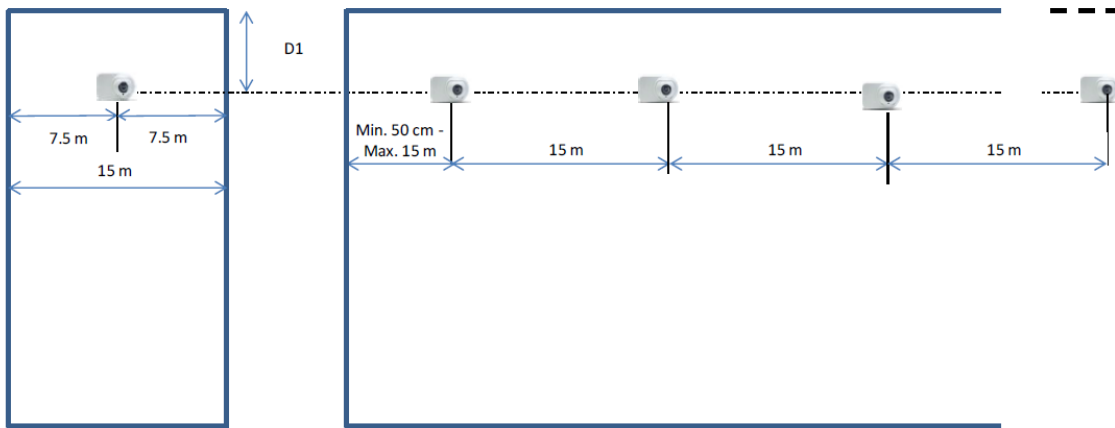

D1 = 60 to 90 cm; 80 cm to 120 cm for roofs > 12 m.

3.4.3 Apex

Apex ceiling refers to slopes > 3.5°

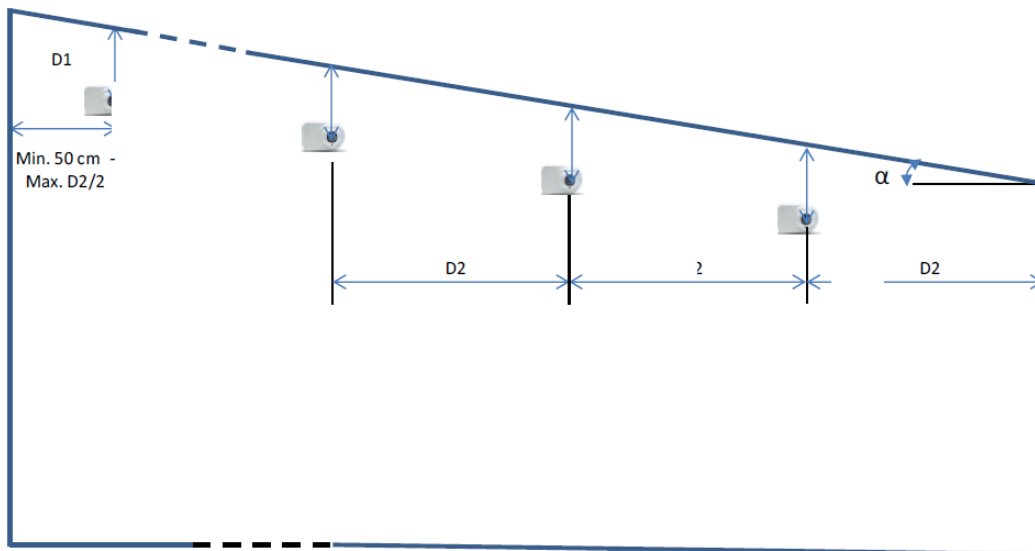

D1 = 60 to 90 cm; 80 cm to 120 cm for roofs > 12 m

$$D2 = 2 \times (7.5 \times (1 + \alpha/100))$$

Applicable up to $\alpha \text{ max} \leq 25^\circ$

Slopes above the 25° shall use the same spacing as a 25° apex = 18.75 m.

3.4.4 Atrium

D1 = 60 to 90 cm; 80 cm to 120 cm for roofs > 12 m

$$D2 = 2 \times (7.5 \times (1 + \alpha/100))$$

Applicable up to $\alpha \text{ max} \leq 25^\circ$

Slopes above the 25° shall use the same spacing as a 25° apex = 18.75 m.

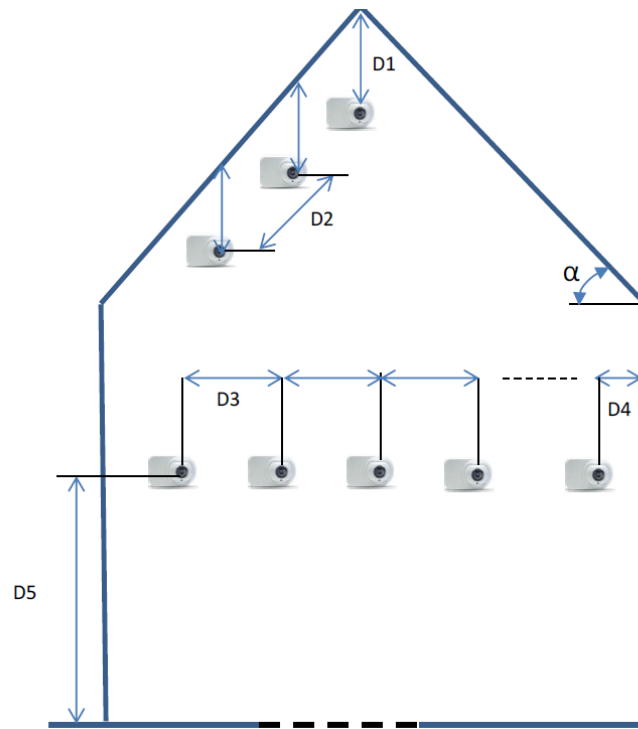

For the earliest detection of a rising smoke plume within a high open space area, the width of the area protected on each side of an optical beam is 12.5 % of the height of the beam above the highest likely seat of a fire.

Example:

For $D5 = 10 \text{ m}$

$D3 = 2 \times (12.5\% \times 10) = 2.5 \text{ m}$

$D4 = 12.5\% \times D5 = 1.25 \text{ m}$

This calculation is based on the fact that a smoke plume has a 15° angle and thus needs to be detected by at least one intermediate beam.

4 Positioning for special applications

Special applications are those where height and/or spacing are outside the typical uses of beams (as normally allowed by codes) and/or areas where the field of view of the beams is particularly challenged as highlighted in the examples below.

4.1 General

For special installations the AHJ's (Authorities Having Jurisdiction) may need to be convinced through on site demonstration. Smoke testing can be conducted to show performance and suitability. The specific site can then be 'approved' based on the conducted tests and result.



Note

Approvals may not be transferrable to other similar sites and tests may be required for each and every individual new site.

4.2 Free view

An OSID Imager operates from the transmitted light that enters the lens. Whilst in theory the Imager only requires a free open area space the size of its lens, the system could be affected by building movement that completely obstructs the transmission patch.



Hence the OSID Imager requires a free transmission space path of 15 cm diameter 'minimum' at all times. Use 20 cm minimum rather than 15 cm if multiple openings are lined up like i.e. openings in consecutive smoke curtains.

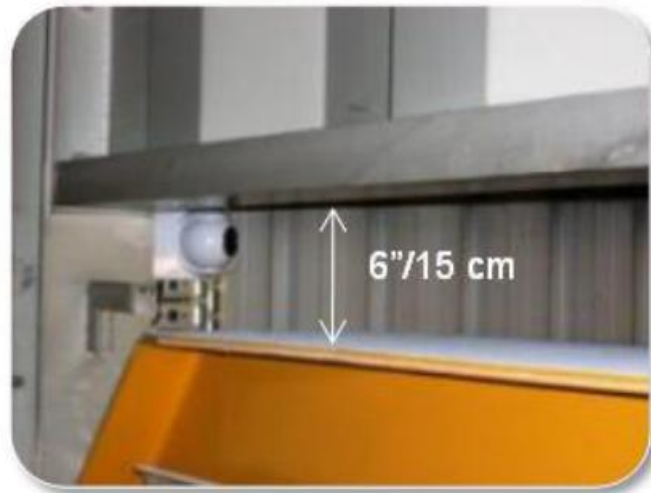

4.3 Cross talk

OSID is a projected beam and each Emitter runs off a pseudo random cycle. As such OSID will not be affected by cross talk unlike traditional projected beams.

4.3.1 Cross talk using 90° Imager

Multi-Emitter solutions can have 2 or more Imagers close to each other in the corner of a building to minimise wiring. Intermediate layer detection for high buildings can also have Emitters very close to one another. In either case, it can get tricky when one or more Emitters are in the field of view of other Imagers with which they are not associated. This is not necessarily a problem provided that the initialisation of the systems is done in a specific manner.

To guarantee that the various Emitters will only communicate with their respective Imager, all non- pairing Emitters need to be COVERED until their proper Imager/system is being initialized.

Once all Imagers and pairing Emitters have been initialised, all 'blocking' can be removed and the systems will then function normally without signalling a fault - 'too many Emitters'.

The pairing Emitters are now memorised by the respective Imagers and will function normally, even after a complete power down or initialize command. Any re-configuration will require all 'Number of Emitter' dip switches to be set to zero and then reset to the right number again or use the recommission button in the OSID Diagnostic tool.

To allow the Imagers to commission multiple Emitters as separate sources, a spatial separation between Emitters of 5 degrees for the OSI-90, is required.

4.3.2 Cross talk using 10° Imagers

However, OSI-10 is designed to work with only one Emitter and having multiple Emitters in its field of view will generate a fault 'Too many Emitters'.

From firmware V4 onwards an OSI-10 will NOT give a 'Too Many Emitters' fault if multiple Emitters are in its field of view and will now commission only the centre most Emitter in the Imager's field-of-view, rejecting all other Emitters.

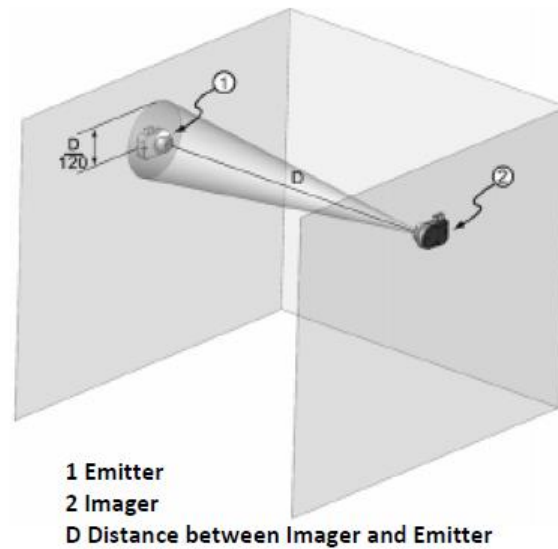

Given the danger of accidentally commissioning the wrong Emitter due to a poorly aligned Imager, the system installation must meet the following conditions for this new mechanism to work.

1. The Imager must be aligned to within 1° of the centre Emitter.
2. Other Emitters can be placed no closer than $\pm 2.5^\circ$ of the centre Emitter. At 100 m, this corresponds to a minimum Emitter spacing of 4.5 m. At 30 m, this corresponds to a minimum Emitter spacing of 1.5 m.

4.4 Areas with very bright environments

When installed in high ambient sunlit environments, ensure direct sunlight does not fall directly onto the OSID components. Installing detectors in a North-South direction will help minimise direct sunlight onto the OSID components and thus reduce saturation issues.



Note

In extremely bright environments, the presence of high ambient sunlight can still create saturation faults.

Open sunlit environments can also create very bright reflective background conditions. Light fixtures and other shiny surfaces within the area may reflect sunlight into the detectors. Always use the sun shield, OSI-LS, on the exposed Imagers. OSI-LS can only be used in 1 on 1 installations. Do not use OSI-LS on Emitters.

It is recommended that, Imagers rather than the Emitters are placed with their back to bright surfaces.



www.xtralis.com

UK and Europe +44 1442 242 330

D-A-CH +49 431 23284 1

The Americas +1 781 740 2223

Middle East +962 6 588 5622

Asia +86 21 5240 0077

Australia and New Zealand +61 3 9936 7000

The contents of this document are provided on an “as is” basis. No representation or warranty (either express or implied) is made as to the completeness, accuracy or reliability of the contents of this document. The manufacturer reserves the right to change designs or specifications without obligation and without further notice. Except as otherwise provided, all warranties, express or implied, including without limitation any implied warranties of merchantability and fitness for a particular purpose are expressly excluded.

Xtralis, the Xtralis logo, The Sooner You Know, VESDA-E, VESDA, ICAM, ECO, OSID, HeiTel, ADPRO, IntrusionTrace, LoiterTrace, ClientTrace, SmokeTrace, XOa, XOh, iTrace, iCommand, iRespond, iCommission, iPIR, and FMST are trademarks and/or registered trademarks of Xtralis and/or its subsidiaries in the United States and/or other countries. Other brand names mentioned herein are for identification purposes only and may be trademarks of their respective holder(s). Your use of this document does not constitute or create a licence or any other right to use the name and/or trademark and/or label.

This document is subject to copyright owned by Xtralis. You agree not to copy, communicate to the public, adapt, distribute, transfer, sell, modify or publish any contents of this document without the express prior written consent of Xtralis.